

Structure Novel Boost Topology for Producing High Quality Supply for HB-LEDs

Yarmohammadi L¹, Afjei S.E² and Siadatan A¹

¹Department of Electrical Engineering, Islamic Azad University at West Tehran Branch, Tehran, IRAN

²Department of Electrical and Computer Engineering, Shahid Beheshti University, Tehran, IRAN

Available online at: www.isca.in, www.isca.me

Received 2nd February 2014, revised 17th May 2014, accepted 1st October 2014

Abstract

This topology presents simple, economical and novel control power factor correction for driving High-brightness LEDs based on Boost converter. Nowadays, HB-LEDs are discussed noticeable lighting instrument because of their great Longevity, Varicolored, and Compatible with Environment. It works by sampling of input and output voltage and current in boost converter, whereupon, improving the input power factor and reduction the line current's Total Harmonic Distortion (THD). Recently, power factor correction (PFC) has become an essential part of new power supply designs. Proposed converter shows a power supply for HB-LED which could work under a large AC input voltage range and obtains high power quality. It is a single stage, low cost and high efficiency. The UC3854 with fast control loop is used to improve power factor and enabling the PWM dimming. We tested the novel control method by simulating and built both converters in the laboratory and final results compared to open loop converter.

Keywords: PFC, HB- LED, THD, boost, power supply.

Introduction

Utilization of power switching converter has become common method for designing a power supply. The main issue on these kinds of converters is the irregularity in current and voltage output¹. Nowadays, manufacturers of lighting fixtures produce the high brightness light emitting diodes (HB LEDs) with high efficiency output above 100 Lumens/Watt². These LED lamps have more advantages such as lower cost, color variety and high luminance intensity. Hence, among the many artificial lighting devices, these are likely to be the best choice for illuminating purposes³⁻⁵.

The drivers of these lamps for output powers over 25W have to be compatible with the requirements of IEC61000-3-2⁶. The Proposed topology makes the HB-LEDs supply to achieve Class C regulations of the same requirement. Obtaining a high PFC is possible by some passive and active circuits⁷. Equation-1, below, shows relation between power factor and THD⁷.

$$P.F = \cos\phi \frac{1}{\sqrt{1 + THD^2}} \quad (1)$$

Where ϕ is the phase angle difference of the voltage and current waveforms? Mathematically, the input voltage of the duly converter is AC whereas its output is DC, to feed LED, as shown in the diagram of figure-1.

This circuit is simple, cheap; in which an IC with power factor correction close to one is newly applied. Finally, results of

tested driver are discussed and compared with IEC 61000 standards.

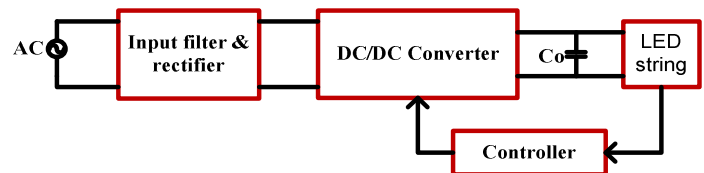

Figure-1

Block diagram of DC/DC converter power factor correction circuit

Analysis of the circuit

Figure-2 shows a boost converter circuit⁸, the mode of dimming control for LED could be rendered through analog or pulse width modulation (PWM) methods¹². Analog dimming method is not proper for HB-LED lamps because of color variation and accurate current control. Therefore PWM dimming is described in this paper. As shown in figure-3, the IC applied in this topology is UC3854. This chip has two functions, first, to stabilize output voltage by sampling output voltage and to modify switch timing and second, to control voltage phase and current phase by changing PWM.

The designed circuit consists of a power MOS switch M1, an inductor L, and a Schottky diode D1 directly connected with the load LEDs, the current sampling resistor R_{sense} and the resistors R_p and R are used to regulate output voltage, as shown in figure-4.

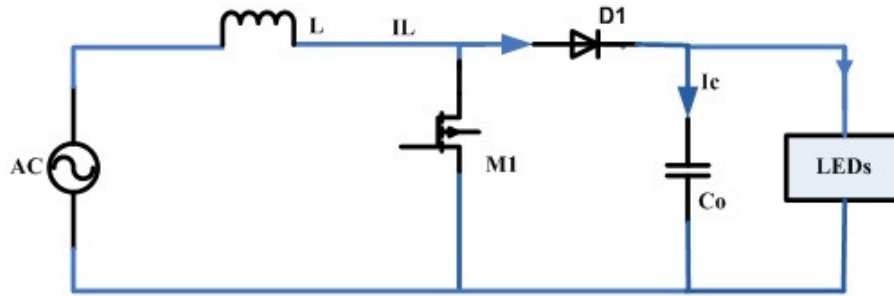

Figure-2
 Circuit diagram of Boost converter

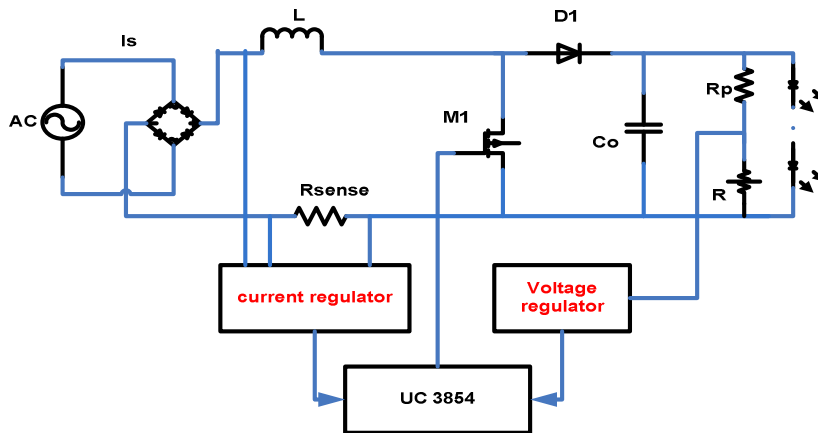

Figure-3
 The circuit of HB-LEDs driving with Boost PFC

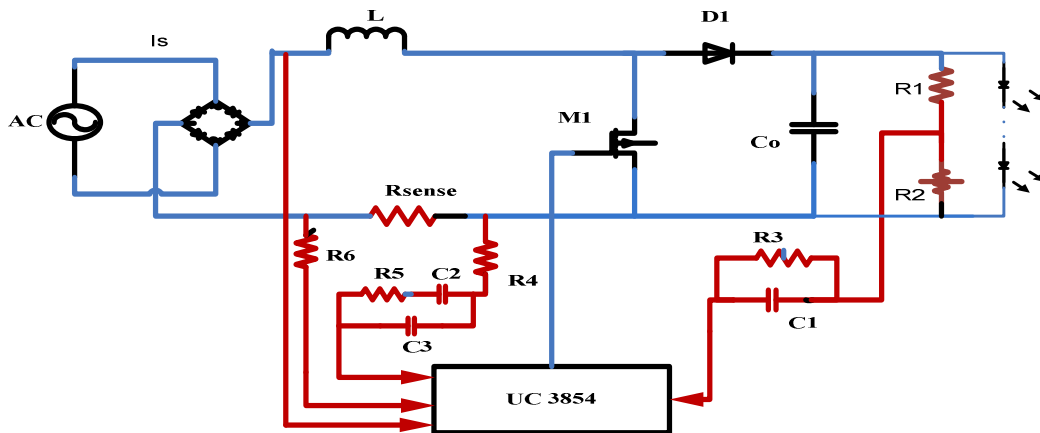

Figure-4
 The experimental circuit of HB-LEDs driving with Boost PFC

Figure-5 and figure-6 show line voltage and line current with and without PF correction. This topology has two feedback loops, to fix range of output voltage and correction PF.

Results of Simulation

The boost converter with PFC is designed and simulated by PSIM software as shown figure-4.

Figure-5 shows the voltage and current input waveforms of the

open loop converter. Figure-6 demonstrates the waveforms of converter with PFC circuit and Figure-7 illustrates the output voltage waveform.

Figure-5 shows the power factor using boost converter circuit without any PF correction to be about 0.78 with THD of 45%. Figure-6 shows the power factor using boost converter circuit with PF correction to be about 0.997 with THD of 11.3%. Figure-7 shows the output voltage to be about 53V.

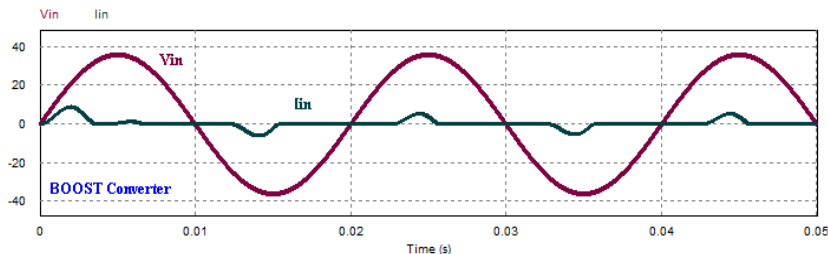

Figure-5
 Input voltage and current waveforms without PFC

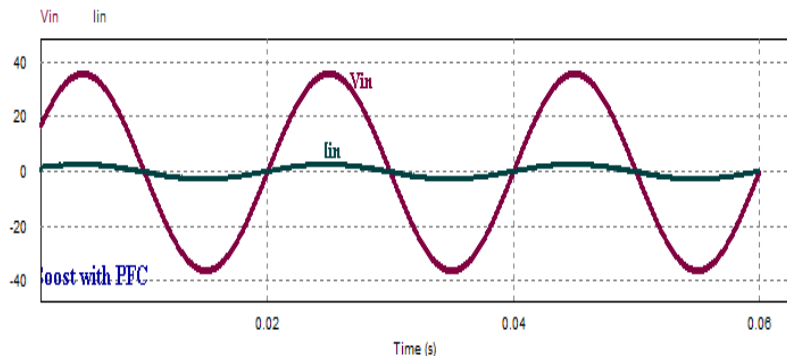

Figure-6
 Input voltage and current waveforms with PFC

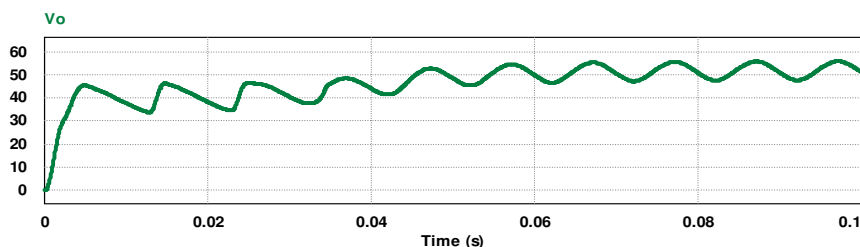

Figure-7
 Output voltage waveform with PFC

Example design and experimental results

In this section, an LED constant current driver with high power factor is designed and built according to the following details: Input voltage: AC, 18 – 36V (nominal 25V), LED string voltage: DC 53V, LED current: 350 mA, Expected efficiency: 90% , P.F: 0.997, Switching frequency: 40 kHz

The load is made of 16 High power LEDs 1 W at 350mA. Figure-8 shows the circuit of modeling load¹³.

So, Equation-2 shows relation between voltage and current of the load:

$$V_D = R_{Di} I_D + V_{\gamma i} \quad (2)$$

Where: V_D : Voltage of the LED load, R_{Di} : Dynamic resistance, I_D : Current load, $V_{\gamma i}$: Threshold voltage.

The LEDs have to be chosen standard because of they have not

the variation of forward voltages. The boost topology driving IC UC3854 with an input DC supply, Voltage range for IC UC3854 is from 15V to 40V and the schematic diagram shown in figure-4. This circuit is used to drive 16 HB-LED with a 3.3V working voltage. Equation-3 shows output voltage of the load.

$$V_o = N (R_{Di} I_D + V_{\gamma i}) = R_D I_D + V_\gamma \quad (3)$$

Where V_o is the load output voltage and N is the number of LEDs.

The close loop circuit of boost with FPC set up as shown in figure-4. The circuit component values used in experimental of the circuit consist of : $V_{in} = 36V$, $L = 1 \text{ mH}$, $C_o = 100\mu F$, $R_1 = 560 \text{ k}\Omega$, $R_2 = 92 \text{ k}\Omega$, $R_3 = 68 \text{ k}\Omega$, $R_5 = 20 \text{ k}\Omega$, $R_4 = R_6 = 2.2 \text{ k}\Omega$, $C_1 = 227 \text{ nF}$, and $C_2 = 1 \text{ nF}$ and $C_3 = 270 \text{ pF}$.

Figure-9 and figure-10 display the input voltage and current

waveforms of the boost converter with and without PFC; output voltage is shown as figure-11

The theory and experimental result of the boost converter without and with PFC based on the IC UC3854 are presented in table-1, we can compare both circuits by this table.

The input current harmonics of boost converter without and with PFC are shown in figure-12.

Table-1
Simulation and Experimental Results

	Simulations		Laboratory Experiments	
	Boost converter without PFC	Boost converter with PFC	Boost converter without PFC	Boost converter with PFC
Cos Φ	0.78	0.997	0.78	0.999
THD	45%	11.3%	50%	11.5%

Figure-13 Corroborates the input current harmonics has compatible with IEC 61000-3-2.

Finally, the PFC and power circuit module are set up in the fiber as shown figure-14. The results show, to achieve power factor to unit.

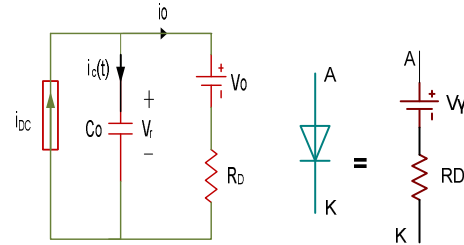

Figure-8
 (Left) Equivalent circuit of an LED: Linear model, (Right) Output dc current equivalent circuit.

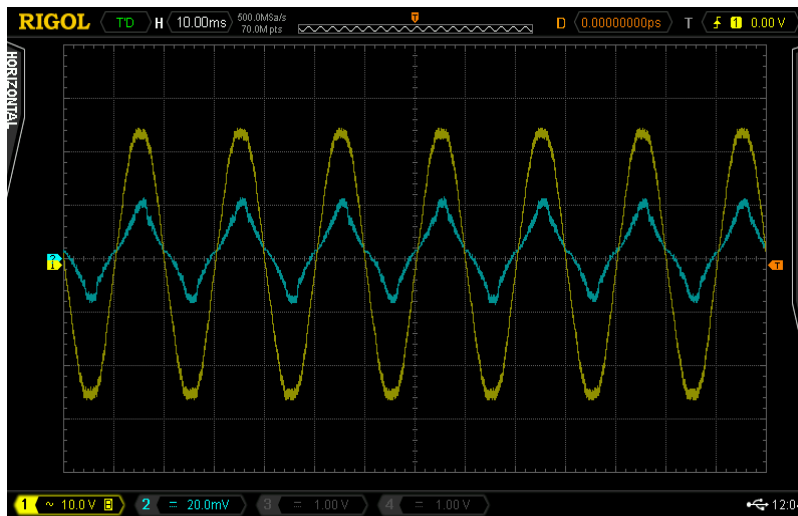

Figure-9

The experimental Input voltage and current waveforms boost converter without PFC

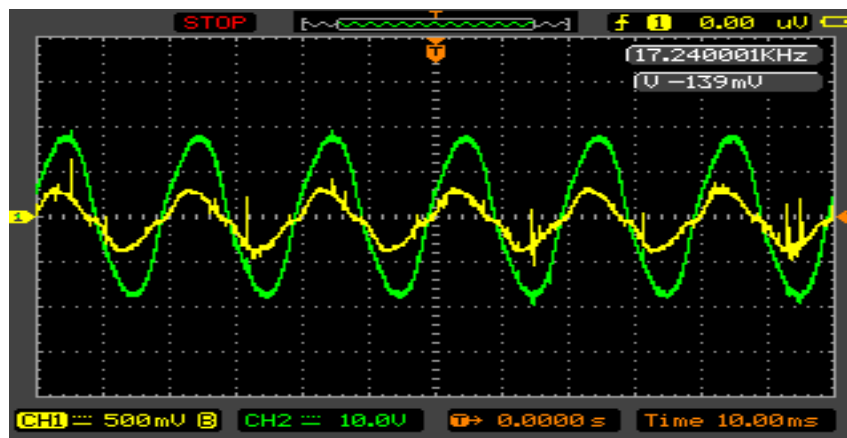

Figure-10

The experimental Input voltage and current waveforms boost converter with PFC

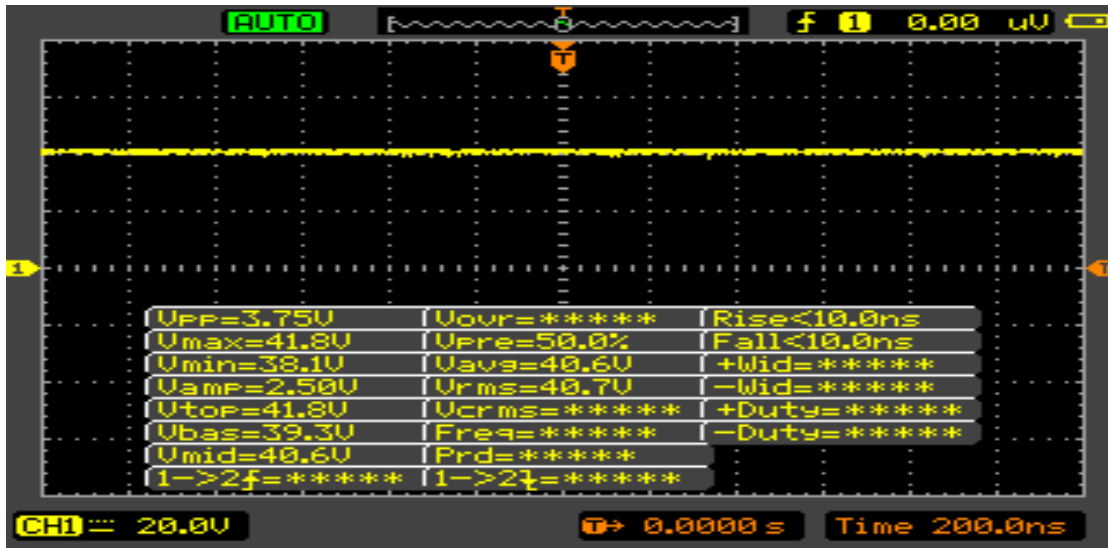

Figure-11
 The experimental output voltage waveform boost converter with PFC

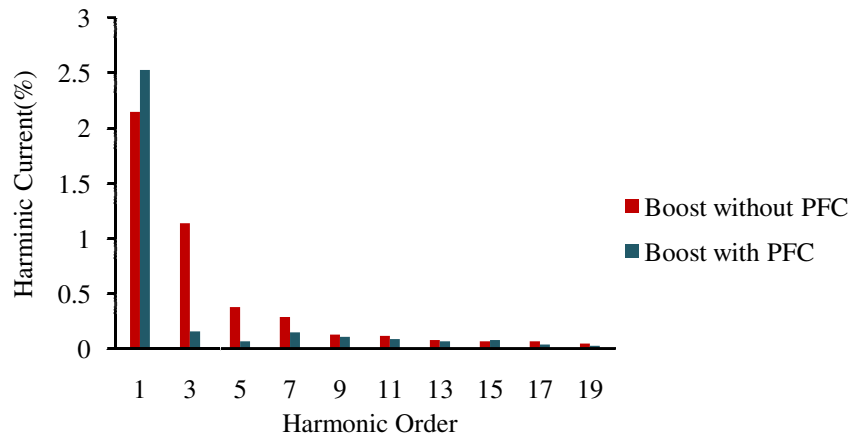

Figure-12
 Input current FFT Boost converter with and without PFC

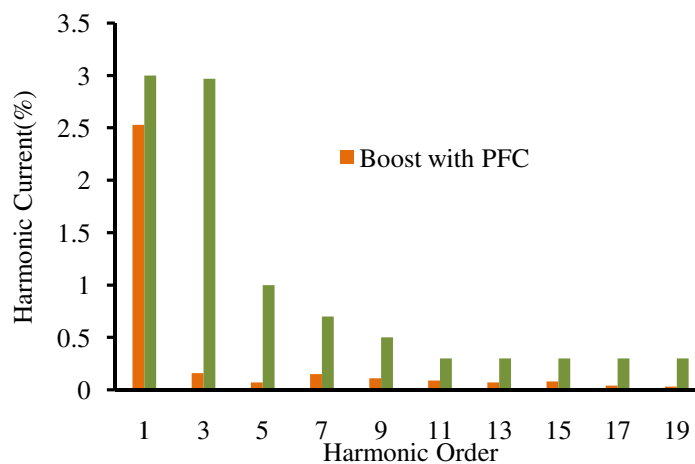
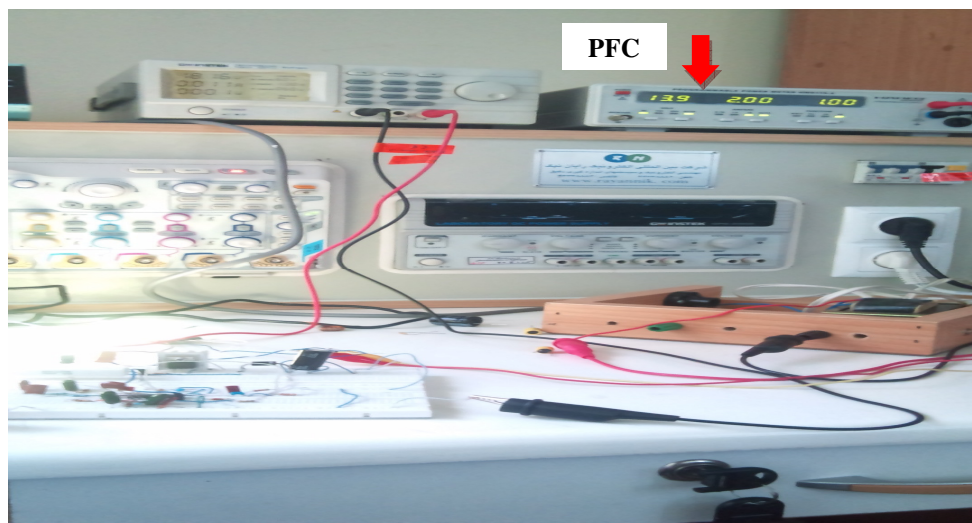

Figure-13

Harmonic content of the input current, showing the results obtained and the limits stated in the IEC 61000-3-2 Regulations



(a) Showing PFC is unit

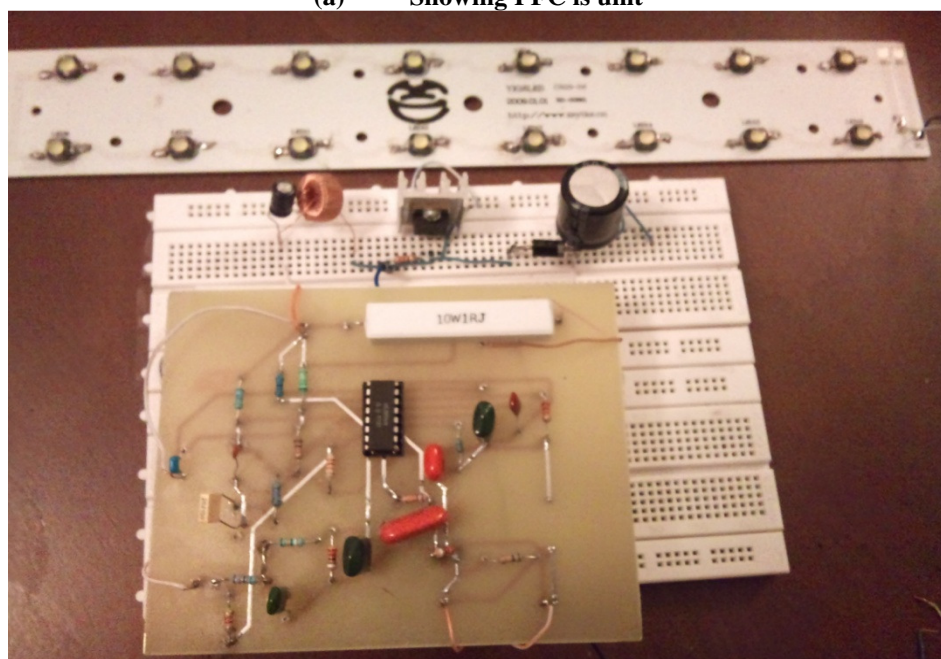

Figure-14
The circuit setup of closed loop Boost with FPC

Conclusion

HB-LEDs constant current drive circuit with high power factor is present in this topology. The control method is applied by IC UC3854. This circuit provides PFC in the boost converter. The boost topology which could drive HB-LEDs with a large AC input voltage range is designed and tested. The measured results on the laboratory prototype show a high efficiency of 90%, high power factor 0.999 at, a good low-frequency harmonic reduction.

References

1. Sujata Verma, S.K Singh and A.G. Rao., Overview of control Techniques for DC-DC converters, *Research Journal of Engineering Sciences*, **2(8)**, 18-21 (2013)
2. Weir B. and Cathell F., LED streetlight demands smart power supply, *Power Electronic Technol.*, **34(2)**, 34-39 (2008)
3. Cheng Y. K. and Cheng K.W.E., General Study for Using LED to replace Traditional Lighting Devices, 2nd International Conference on Power Electronics Systems and Applications, Hong Kong, (2006)
4. E.W. Wu, T.Fu. Wu, J.R. Tsai, Y.M. Chen and C.C. Chen, Multistring LED Backlight Driving System for LCD Panels with Color Sequential Display and Area

- Control, *IEEE Transactions on Industrial Electronics*, **54(10)**, 3791-3800 (2008)
5. Rico-Secades M., Calleja A. J., Ribas J., Corominas E. L., Alonso J. M., Cardesin J. and Garcia-Garcia J., Evaluation of a Low-Cost Permanent Emergency Lighting System Based on High-Efficiency LEDs, *IEEE Transactions on Industry Applications*, **41(5)**, 1386-1390 (2005)
 6. OLeary M., Plug in safeguard AC power line quality, *EDN*, 57-66 (2004)
 7. Jain Sandesh, Thakur Shivendra Singh and Phulambrikar S.P, Improve Power Factor and Reduce the Harmonics Distortion of the System Technological, *Research Journal of Engineering Sciences*, **1(5)**, 31-36 (2012)
 8. Gokaraju Rangaraju Bachupally, Kukatpally, Hyderabad, A.P., A New Active Power Factor Correction Controller using Boost Converter, *Research Journal of Engineering Sciences*, **2(8)**, 7-11 (2013)
 9. Wolfle W.H. and Hurley G., Quasi-active power factor correction with a variable inductive filter: Theory, design, and practice, *IEEE Trans. Power Electron.*, **18(1)**, 248-255 (2000)
 10. Loo K.H., Lun W.K., Tan S.C., Lai Y.M. and Tse C.K., On Driving Techniques for LEDs: Toward a Generalized Methodology, *IEEE Transactions on Power Electronics*, **24(12)**, 2967-2976 (2009)
 11. Nishika M., Ishizuka Y. and Matsuo H. *et al.*, An LED Drive Circuit with Constant Output Current Control and Constant Luminance Control, *28th Telecommunications Energy Conference*, Providence, 1-6 (2006)
 12. Broeck H.V.D., Sauerlander G. and Wendt M., Power Driver Topologies and Control Schemes for LEDs, *Twenty Second Annual IEEE of Applied Power Electronics Conference*, Anaheim, 1319-1325 (2007)
 13. Gacio D., Alonso J. M., Calleja A. J., García J. and Secades M.R., A universal input single stage high power factor power supply for HB LEDs based on integrated buck flyback converter, *IEEE Trans. Ind. Electron.*, **58(2)**, 589-599 (2011)